

Akuvox Smart
Intercom

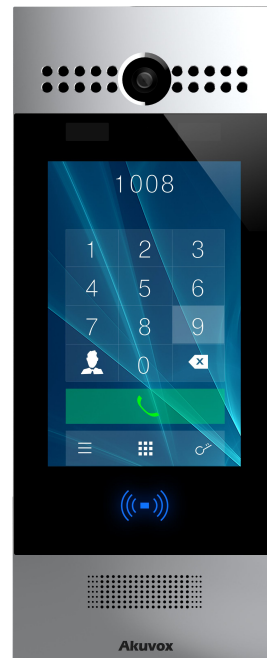

R29 Series Door Phone User Manual

About This Manual

Thank you for choosing Akuvox's R29S/F door phone. This manual is intended for end users, who need to properly configure the door phone. It provides all functions and configuration of R29S/F, the information detailed in this user manual applicable to firmware version 29.0.1.224.zip or lower version.

- Please verify the packaging content and network status before setting.
- The old firmware may be a little different from 29.0.1.224.zip about some configuration. Please consult your administrator for more information.

Contact Us

For more information about the product, please visit us at www.akuvox.com or feel free to contact us by

Sales email: sales@akuvox.com

Technical support email: techsupport@akuvox.com

Telephone: +86-592-2133061 ext.7694/8162

We highly appreciate your feedback about our products.

 **FCC Caution:**

Any Changes or modifications not expressly approved by the party responsible for compliance could void the user's authority to operate the equipment.

This device complies with part 15 of the FCC Rules. Operation is subject to the following two conditions : (1) This device may not cause harmful interference, and (2) this device must accept any interference received, including interference that may cause undesired operation.

Note : This equipment has been tested and found to comply with the limits for a Class B digital device, pursuant to part 15 of the FCC Rules. These limits are designed to provide reasonable protection against harmful interference in a residential installation. This equipment generates, uses and can radiate radio frequency energy and, if not installed and used in accordance with the instructions, may cause harmful interference to radio communications. However, there is no guarantee that interference will not occur in a particular installation. If this equipment does cause harmful interference to radio or television reception, which can be determined by turning the equipment off and on, the user is encouraged to try to correct the interference by one or more of the following measures:

- Reorient or relocate the receiving antenna.
- Increase the separation between the equipment and receiver.
- Connect the equipment into an outlet on a circuit different from that to which the receiver is connected.
- Consult the dealer or an experienced radio/TV technician for help.

Specific Absorption Rate (SAR) information

SAR tests are conducted using standard operating positions accepted by the FCC with the device transmitting at its highest certified power level

in all tested frequency bands, although the SAR is determined at the highest certified power level, the actual SAR level of the device while operating can be well below the maximum value. Before a new product is available for sale to the public, it must be tested and certified to the FCC that it does not exceed the exposure limit established by the FCC, tests for each phone are performed in positions and locations as required by the FCC.

For headset, this part has been tested and meets the FCC RF exposure guidelines when used with an accessory designated for this product or when used with an accessory that contains no metal.

For baseband, this equipment complies with FCC radiation exposure limits set forth for an uncontrolled environment. This equipment should be installed and operated with minimum distance 20cm between the radiator & your body.

Content

| | |
|---|---|
| 1. Product overview | 1 |
| 1.1. Product Description..... | 1 |
| 1.2. Connection Introduction..... | 2 |
| 2. Daily Use | 3 |
| 2.1. Making a Call..... | 3 |
| 2.1.1. Calling From Digital Keypad..... | 3 |
| 2.1.2. Calling From Phonebook..... | 3 |
| 2.2. Receiving a Call..... | 4 |
| 2.3. Unlock..... | 5 |
| 2.3.1. Public Key..... | 5 |
| 2.3.2. Private Key..... | 5 |
| 2.3.3. Unlock by Face..... | 6 |
| 2.3.4. Unlock by RF (Radio-Frequency) Card..... | 6 |
| 2.3.5. Unlock by DTMF code..... | 7 |

1. Product overview

1.1. Product Description

29S is an Android-based IP video door phone with a touch screen. It incorporates audio and video communications, access control and video surveillance.

Its finely-tuned Android OS allows for feature customization to better suit the habit of usage of local people. Powered by it, R29S's multiple ports, such as RS485 and Wiegand ports, can be used to easily integrate external digital systems, such as elevator controller and fire alarm detector, helping to create a holistic control of building entrance and its surroundings and giving occupants a great sense of security.

It is applicable to multi-storey residential buildings, high-rise office buildings and their complexes.

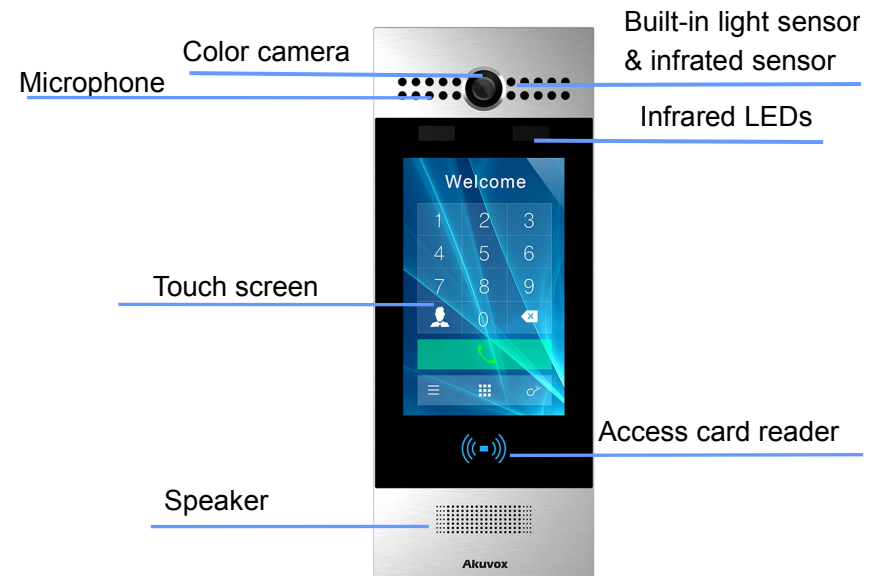

1.2. Connection Introduction

Ethernet(POE): Ethernet(POE) connector which can provide both power and network connection.

12V/GND: External power supply terminal if POE is not available.

WG_D0/1: Wiegand terminal for wiegand access control.

RS485A/B: RS485 terminal for automation system control(e.g. Elevator control).

DOORA/B/C: Trigger signal input terminal(e.g. Press indoor button to open relay).

RelayA/B/C: NO/NC Relay control terminal.

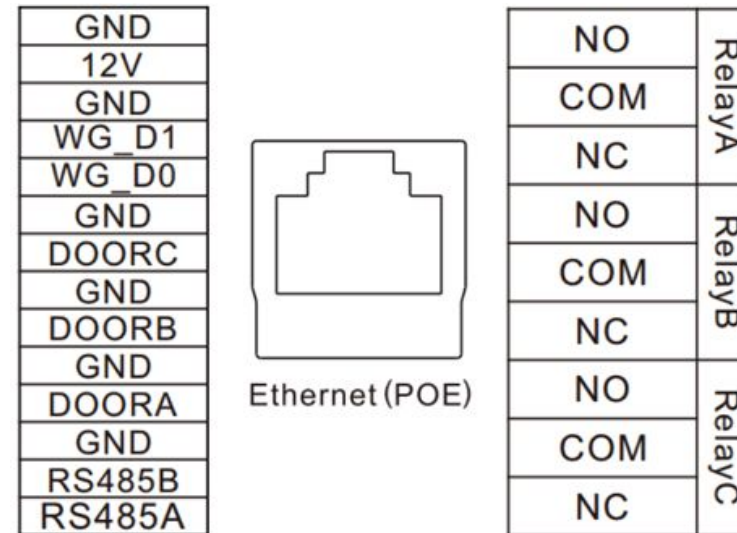

2. Daily Use

2.1. Making a Call

There are two ways to make a call from the door phone to monitor units, which can be an indoor monitor or an intercom app.

2.1.1. Calling From Digital Keypad

- ① The default interface of the door phone is the dial interface.
- ② Enter the number to call on the digital keypad, for example room number 101.
- ③ Tap the dial icon.

2.1.2. Calling From Phonebook

- ④ Tap the icon to enter the phonebook.
- ⑤ To find a specific occupant, scroll up or down the pre-imported

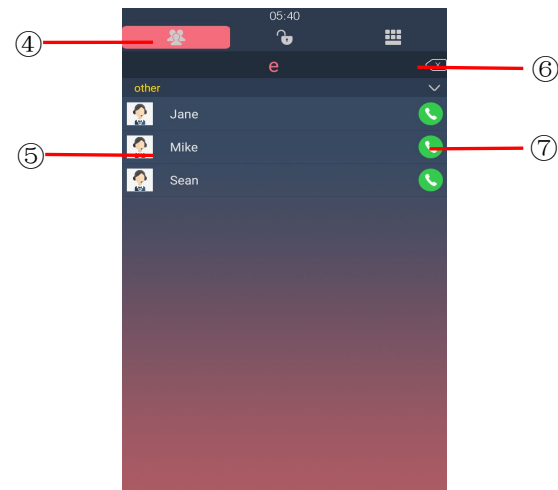
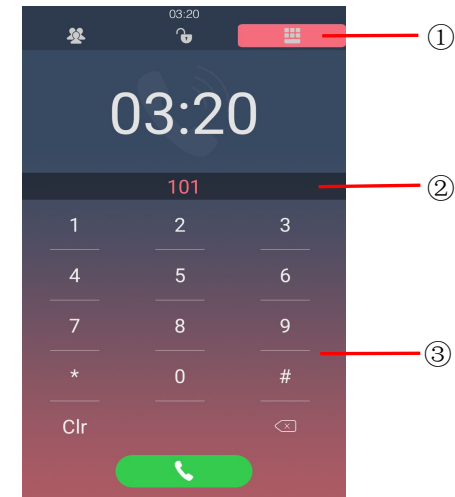

contact list, which is either a room number, an occupant's name, or the combination of both.

⑥ Search the list by alphabet.

⑦ Tap the dial key next to the contact found.

2.2. Receiving a Call

When a monitor unit calls the door phone, it will auto answer the incoming call by default. There is no need to press any answer key.

2.3. Unlock

There are multiple ways of opening door.

2.3.1. Public Key

Public key is a 8-digit password used by all occupants in a building.

- ① Tap the icon to enter the unlock interface.
- ② Enter the public key on the unlock interface, for example 33333333, the default public key of the door phone.
- ③ Tap the unlock icon to open door.

2.3.2. Private Key

Private key is an exclusive 8-digit password for each occupant in a building, which could be set with the help of the door phone administrator.

Same as the public key, ② enter the private key on the digital

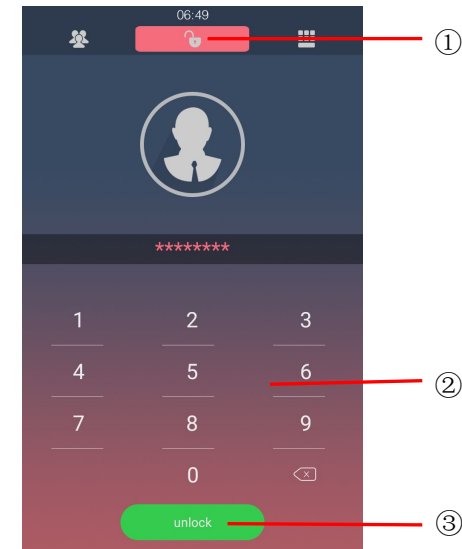

keypad and ③tap the unlock icon to open door.

2.3.3. Unlock by Face

Unlock by Face, users need to put four different angles of your face into the device, which could be set with the help of the door phone administrator. ①Enter Unlock interface, close your face to the camera. You will hear “the door is opened”

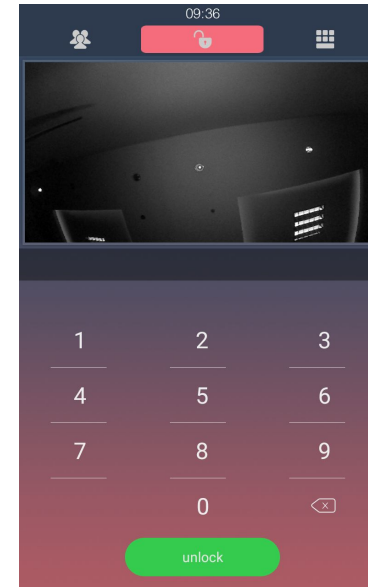

2.3.4. Unlock by RF (Radio-Frequency) Card

R29 series is compatible with both 13.56MHz and 125KHz RF cards. ④Place the card near the reader and you will hear “The door is now opened.”



2.3.5. Unlock by DTMF code

During the call between the answer unit and the door phone, the occupant tap the unlock key on the monitor unit to grant access.